

QuickFlex Walls®



With QuickFlex Walls®, you can build an office or conference room in no time without needing a single tool. Each panel features tempered glass and a heavy-duty aluminum frame that sets up easily using our patent-pending quick-locking system, and optional wall and ceiling anchors are available to allow you to set up in any space. QuickFlex Walls® are designed with a silver finish that complements any professional workspace.

- Patent-Pending Quick-Locking System
- Heavy-Duty Aluminum Frame
- Simple Assembly
- Door Kits Available
- Writable Tempered Glass Surface
- UL1286 Listed, UL723 Certified (Felt Panels Only), SGCC Certified (Glass Panels Only), Meets or Exceeds ANSI/BIFMA X5.6 Standards, and Greenguard and Greenguard Gold Certified

Finishes: Slate Silver

Top Panel: Glass Glass Frosted Frosted Frosted White Board Frosted Felt Felt

Lower Panel: Glass Glass Frosted Frosted Frosted White Board Frosted Felt Felt

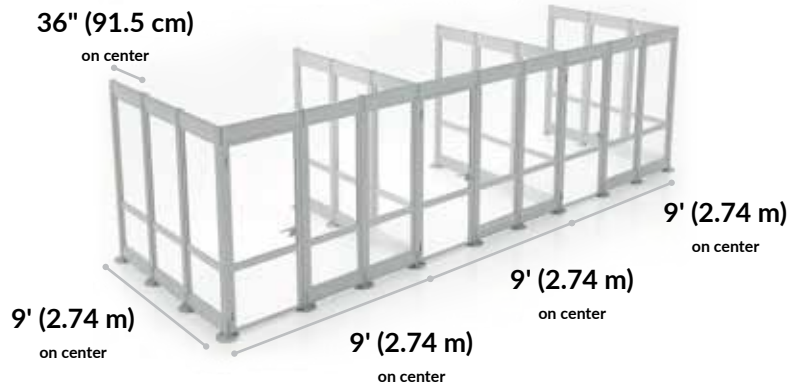

QuickFlex Walls® - Accessories



vari®

Designed to enhance our QuickFlex Walls®, our line of accessories makes it easy to create an office or conference room that meets your unique needs. Whether you need stability or a power strip, we've got you covered.



Stability Brace

The Stability Brace attaches to the bottom of QuickFlex Walls® for additional stability.

Finishes:  Slate  Silver



PowerStrip Bracket



Conveniently add a power strip to any QuickFlex Wall® with our Power Strip Bracket.

Finishes:  Slate



Stability Rail



The Stability Rail attaches to the top of QuickFlex Walls® for additional stability.

Finishes:  Slate  Silver



Anchor Base Plate



The Anchor Base Plate provides additional stability in compliance with seismic code requirements.

Finishes:  Slate  Silver



Felt Extension Panels

Available in 24" and 36" heights, these panels attach to the Stability Rail, extending QuickFlex Walls® vertically to increase privacy and sound dampening.

Finishes:  Slate  Silver