

Glass Board 72x48

vari®

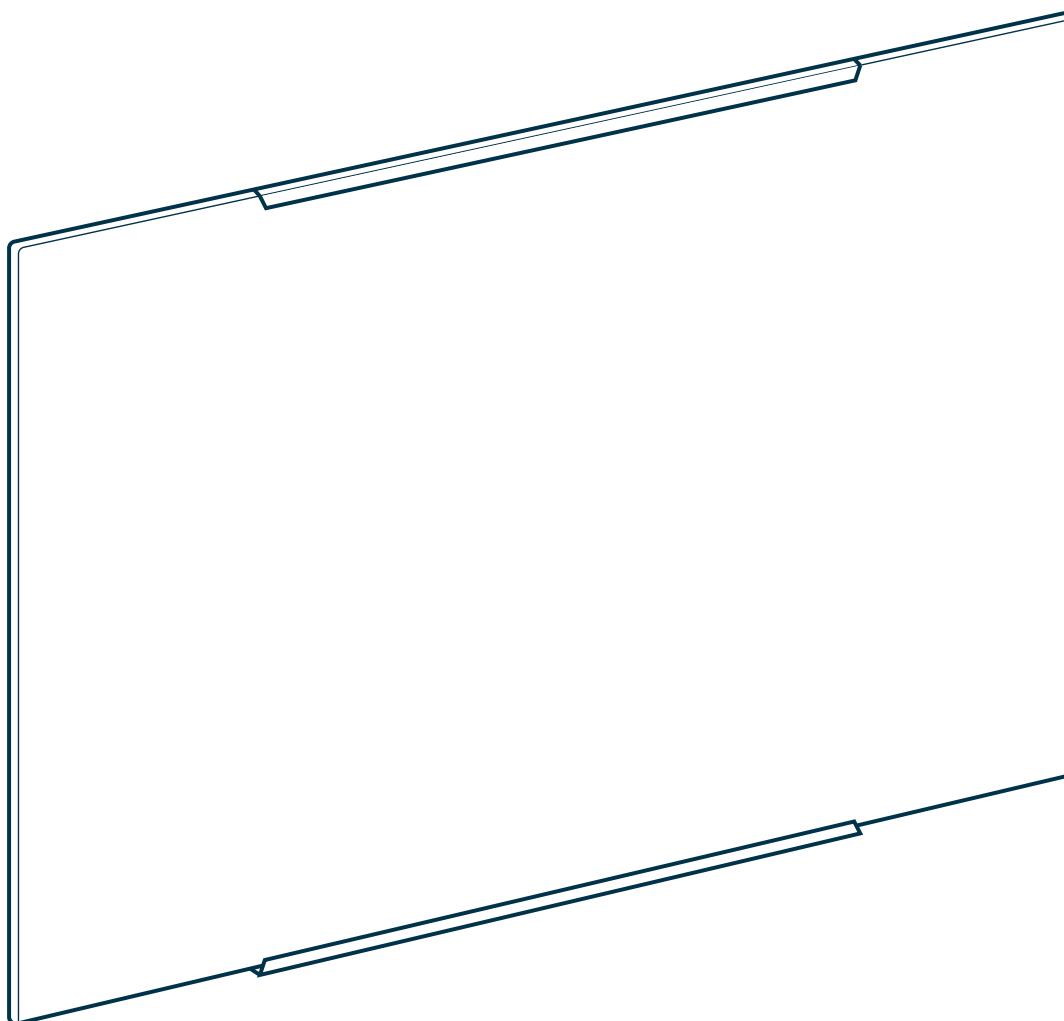

2 People Required





WARNING: Use this mounting system only for its intended use as described in these instructions. Do not use attachments not recommended by the manufacturer.



WARNING: Do not use this product outdoors.



WARNING: Failure to read, thoroughly understand, and follow all instructions can result in serious personal injury, damage to equipment, or voiding of factory warranty. It is the installer's responsibility to make sure all components are properly assembled and installed using the instructions provided.



WARNING: Failure to provide adequate structural strength for this component can result in serious personal injury or damage to equipment. It is the installer's responsibility to make sure the structure to which this component is attached can support five times the combined weight of all equipment. Reinforce the structure as required before installing the component. The wall to which the mount is being attached may have a maximum drywall thickness of 5/8" (wood stud or concrete installations).

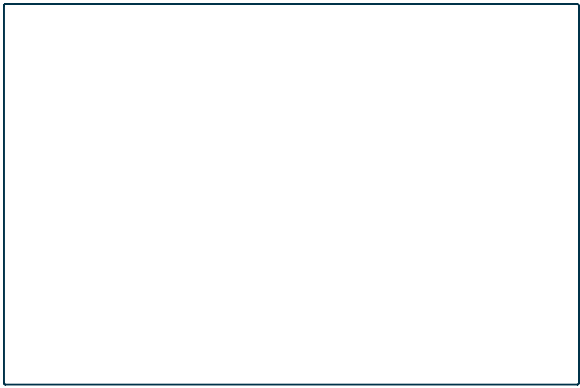

Glass Board

x1

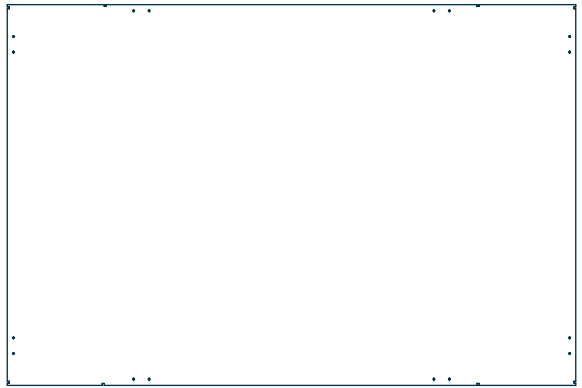

Glass Board Template
(Cardboard)

x1



x1

Top Bracket



x1

Bottom Bracket

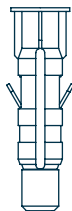

x6

Wall Anchors

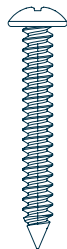

x6

Screws

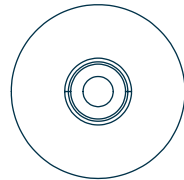

x2

Spacers

1***We recommend using a level and a stud finder for this step**

Determine where you want to position the Glass Board on the wall by measuring up from the floor. We recommend that the bottom of the markerboard be at least 2.5 ft off the ground.

With Wall Studs:

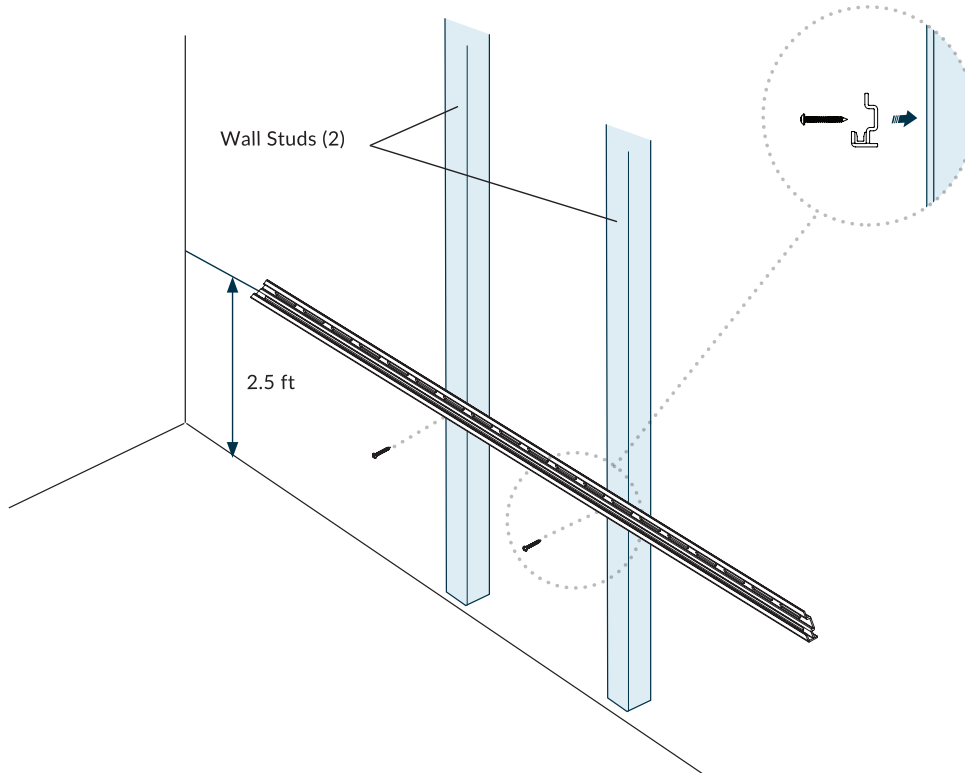

Using a level to ensure that your Glass Board will be positioned properly, locate two (2) studs using a stud finder and use the Bottom Bracket as a guide to mark where the screws will be placed. Use two (2) screws to secure the Bottom Bracket to the wall.

Without Wall Studs:

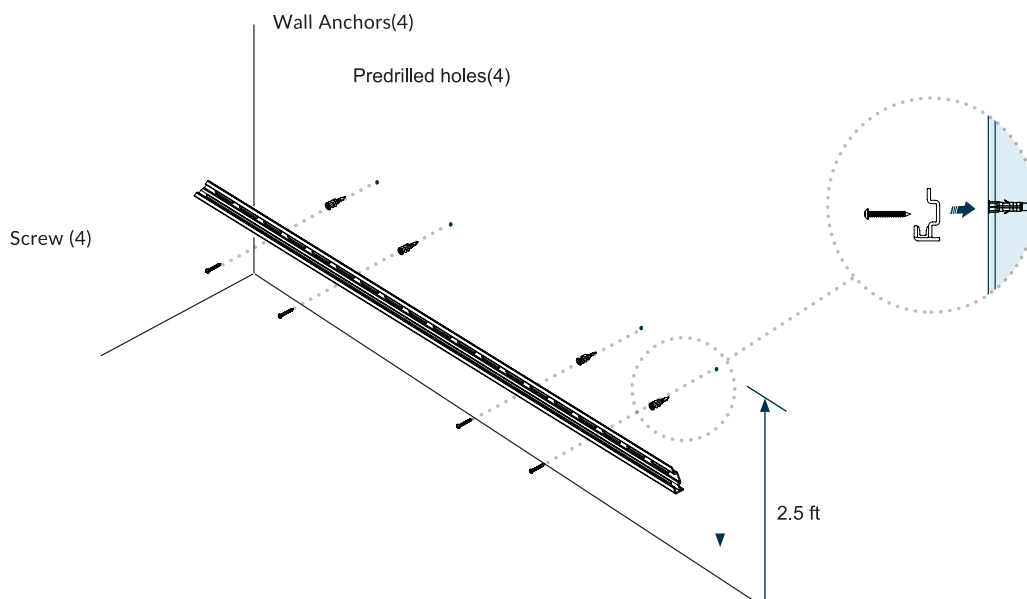

Using a level to ensure that your Glass Board will be positioned properly, mark where the four (4) wall anchors will be placed using the Bottom Bracket as a guide. Pre-drill holes and insert wall anchors. Use four (4) screws to secure the Bottom Bracket to the wall.

3.

2

Using the notched cut-outs, center the Template on the Bottom Bracket. The Template can be used in a vertical or horizontal orientation depending on how you plan to hang your Glass Board.

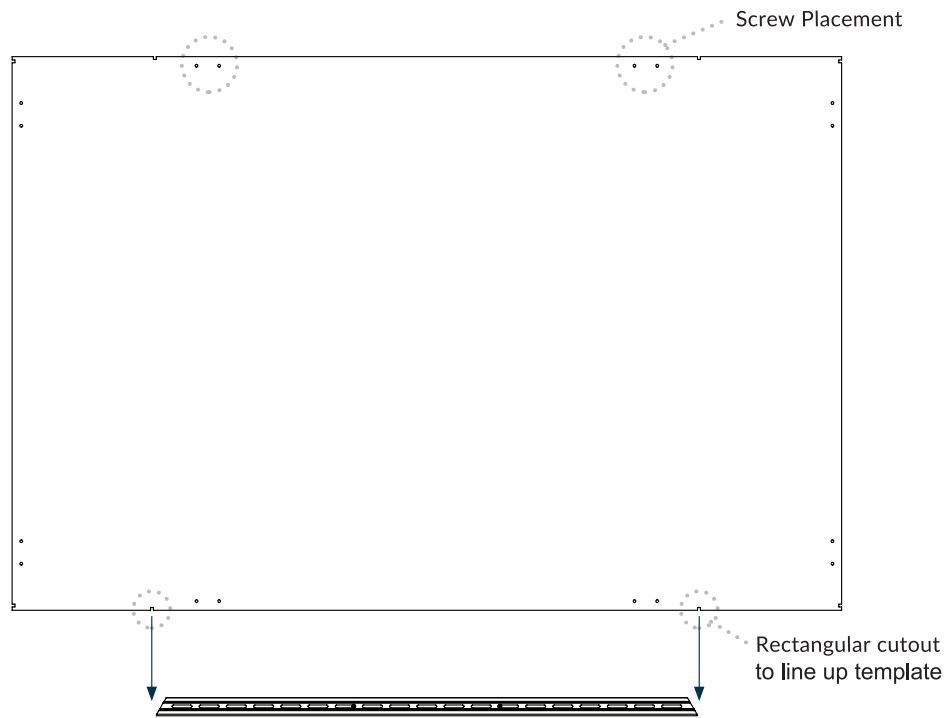

Use the holes near the top edge of the Template to mark where the screws will be placed. Only two (2) screws are required. If possible, try to line up your marks with wall studs. If no studs are available, pre-drill holes and insert wall anchors.

Remove the Template when complete.

3

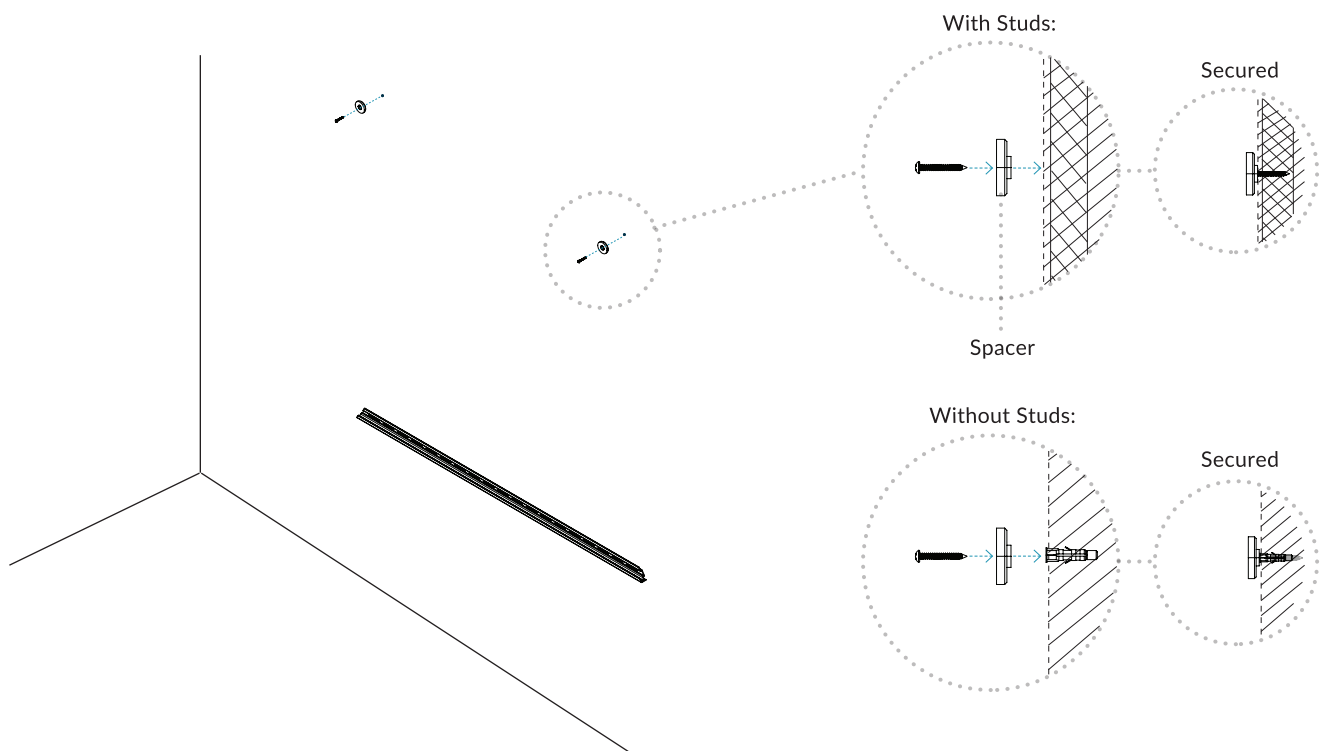

Position the center of the spacers over the marks or wall anchors and then secure them to the wall using screws.

4



*This step requires two people

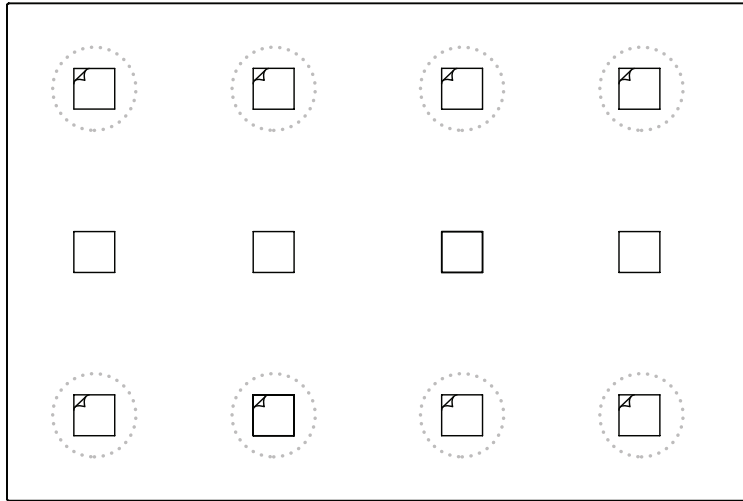

Remove the protective film from the adhesive foam squares at the edges of the Glass Board. With the help of another person, **carefully** lift the Glass Board and position it on the Bottom Bracket.

CAUTION: When lifting, Do not to bend or twist the Glass Board

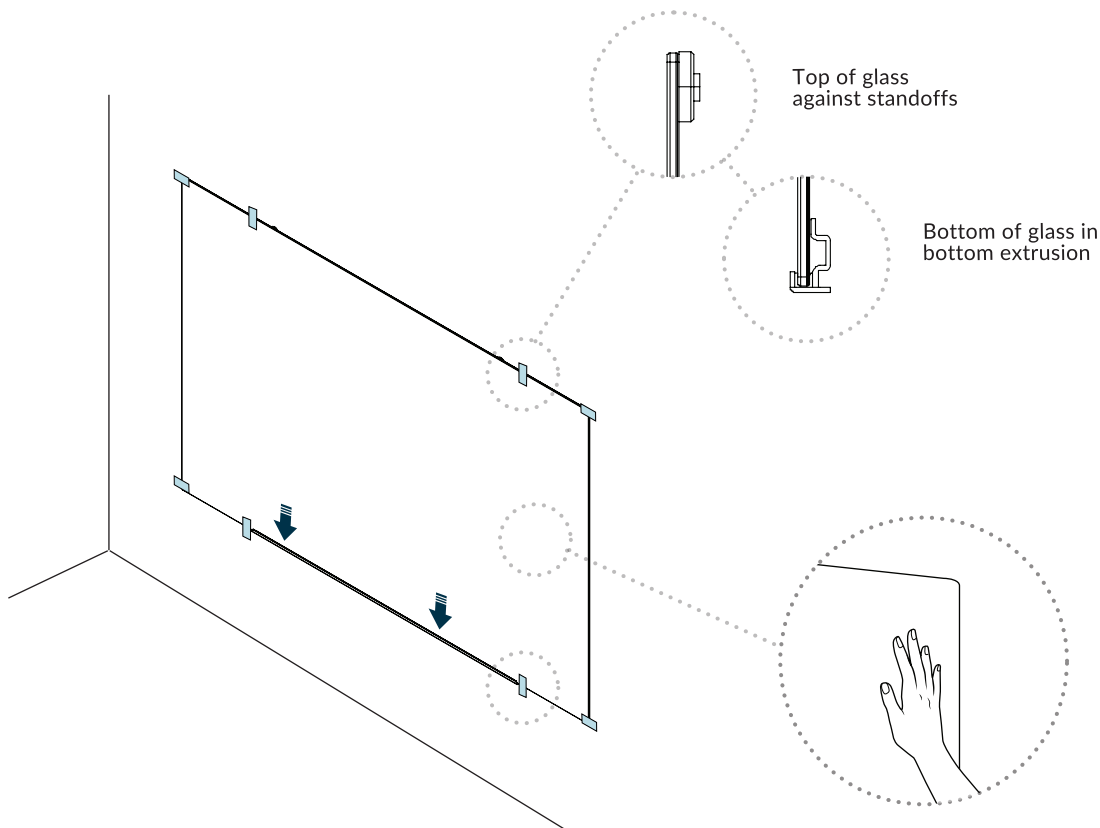

Use the red stickers on the front of the Glass Board to center the board, and then gently place the glass against the wall so that it rests on the Bottom Bracket. **DO NOT** let go of the glass - one person must keep holding the Glass Board against the wall until the end of step 5.

5.

5

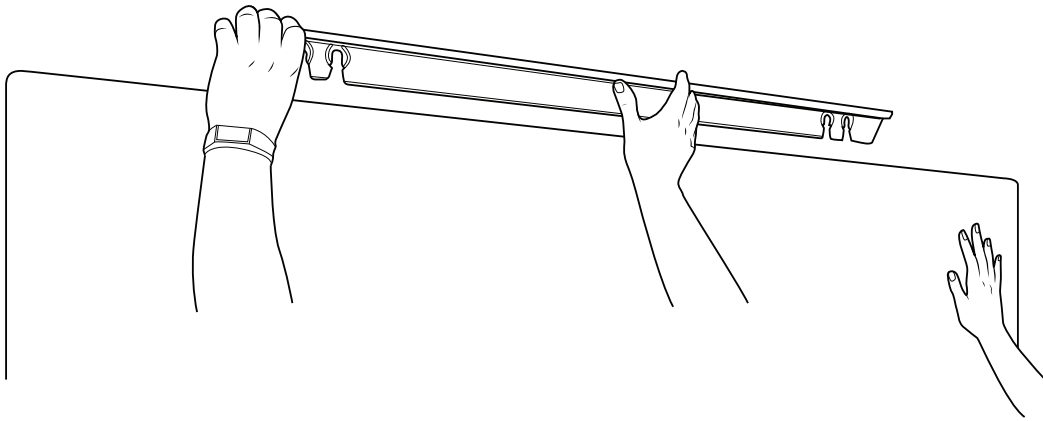

While one person holds the Glass Board against the wall, the other person aligns the cutouts in the Top Bracket with the spacers on the wall.

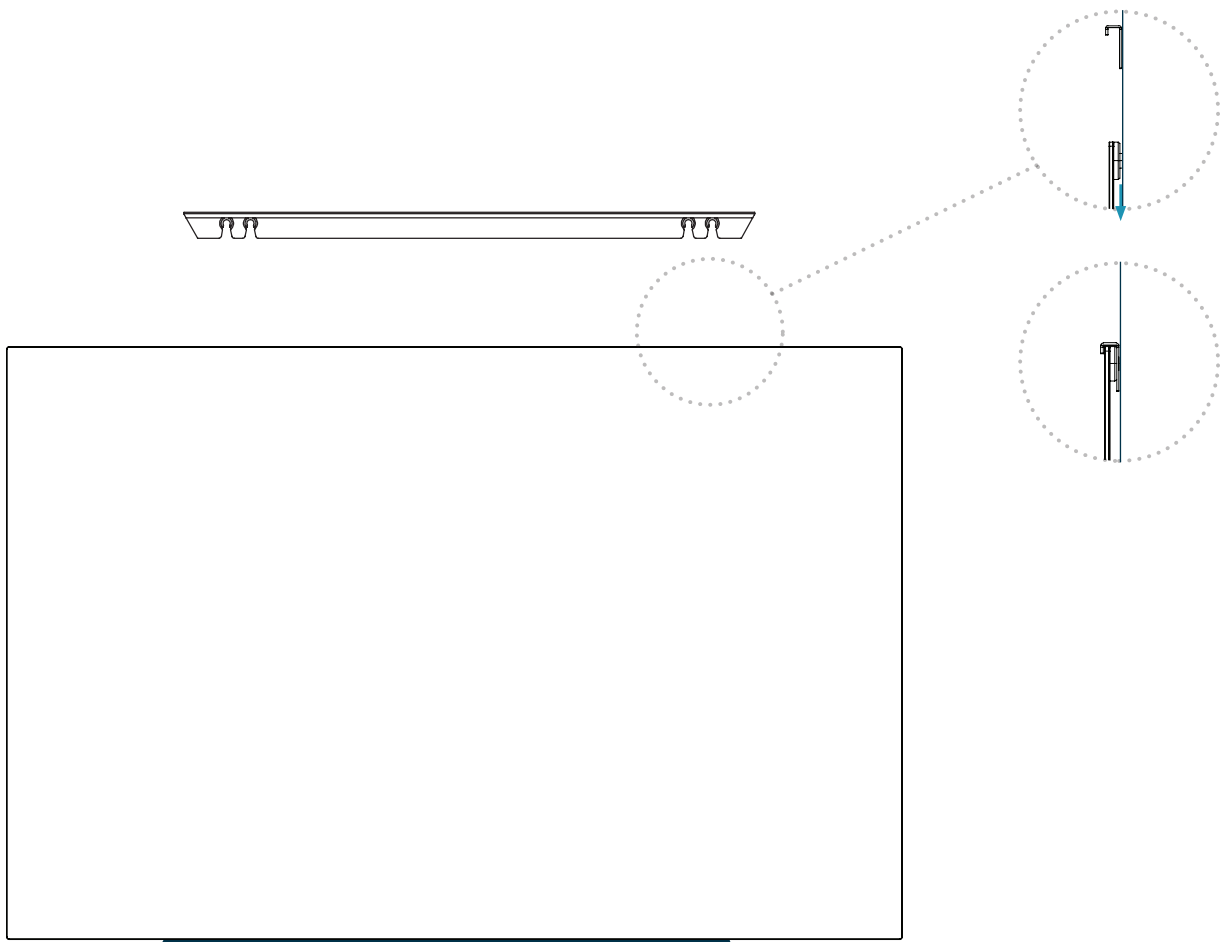

Slide the Top Bracket down over the spacers until it audibly clicks into place. The Glass Board is now fully installed.



(800) 207-2587

vari.[®]