

Flip Top Training Table 6'



2 People
Required



Holds up to
125 lb (56.7 kg)

vari®

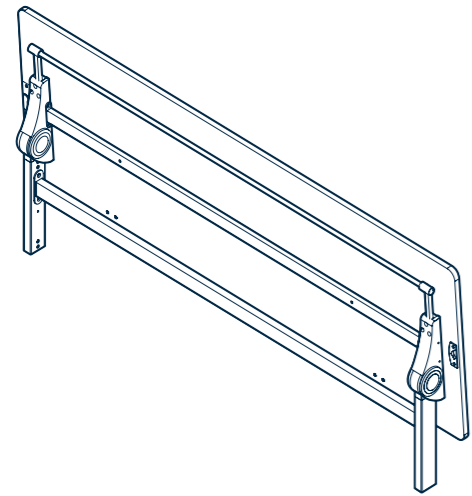

x1
TABLE TOP
WITH LEGS

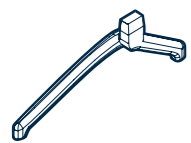

x1
LEFT FOOT

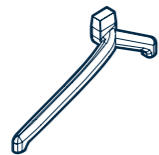

x1
RIGHT FOOT

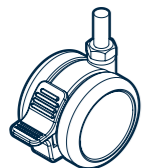

x2 a
CASTERS
WITH LOCK

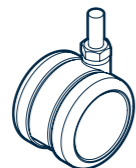

x2 b
CASTERS
WITHOUT LOCK

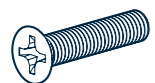

x4
M5 X 28L PHILLIPS HEAD SCREW

REQUIRED TOOLS (Not Included)



PHILLIPS HEAD SCREWDRIVER

1

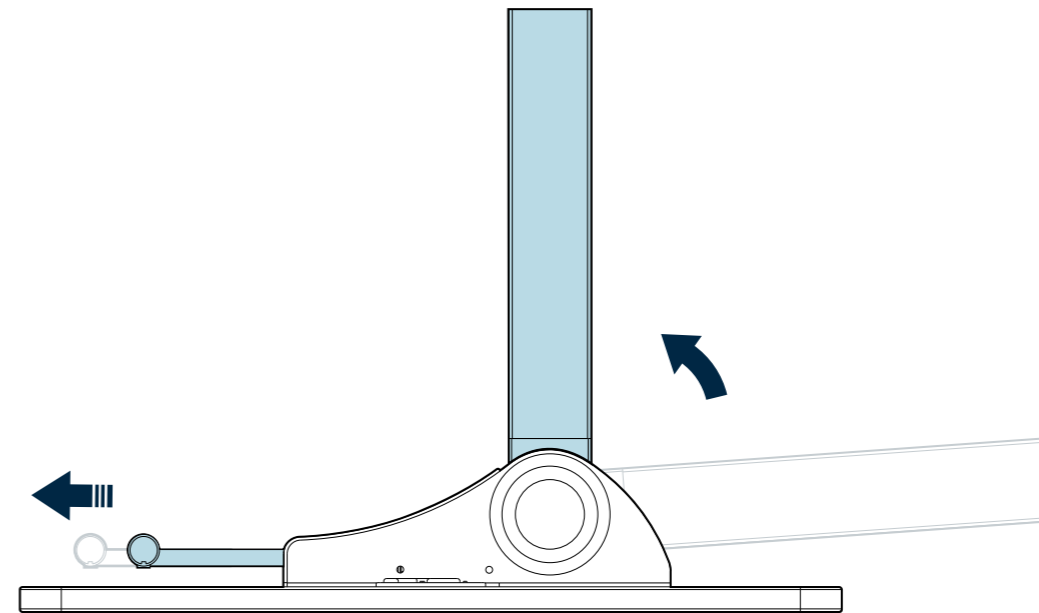

NOTE: To protect your new table, complete this step while it is still face down in the box. Using two hands, pull the locking mechanism out toward the edge of the table and hold in place. Rotate the legs 90 degrees until upright, then release the leg locking mechanism.

2

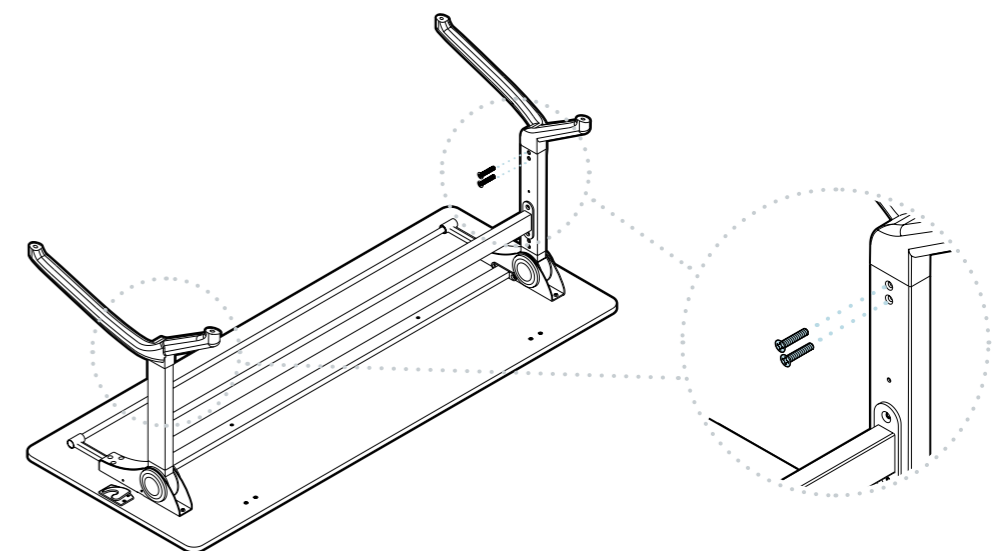
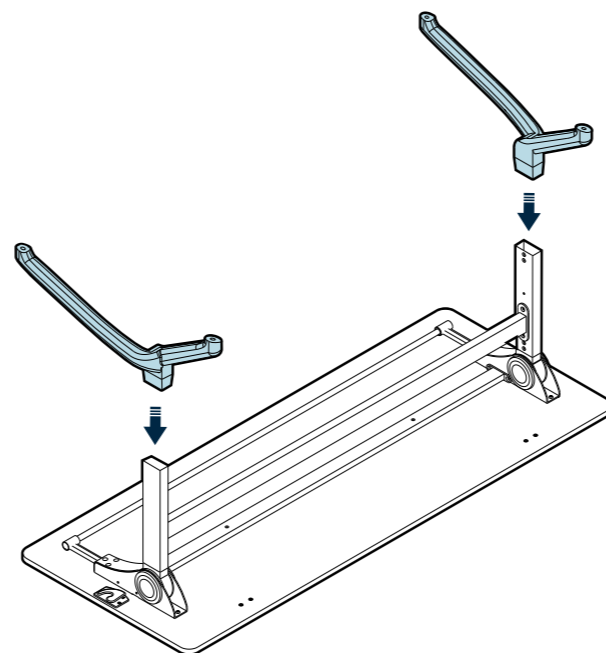

Following the "L" (left) and "R" (right) indicators on the feet and the interior side of the legs, insert the feet into the corresponding legs of the table. Using a Phillips screwdriver and the included screws, secure both feet in position. If you purchased a modesty panel, please refer to the separate instructions included with the modesty panel before moving on to the next step.

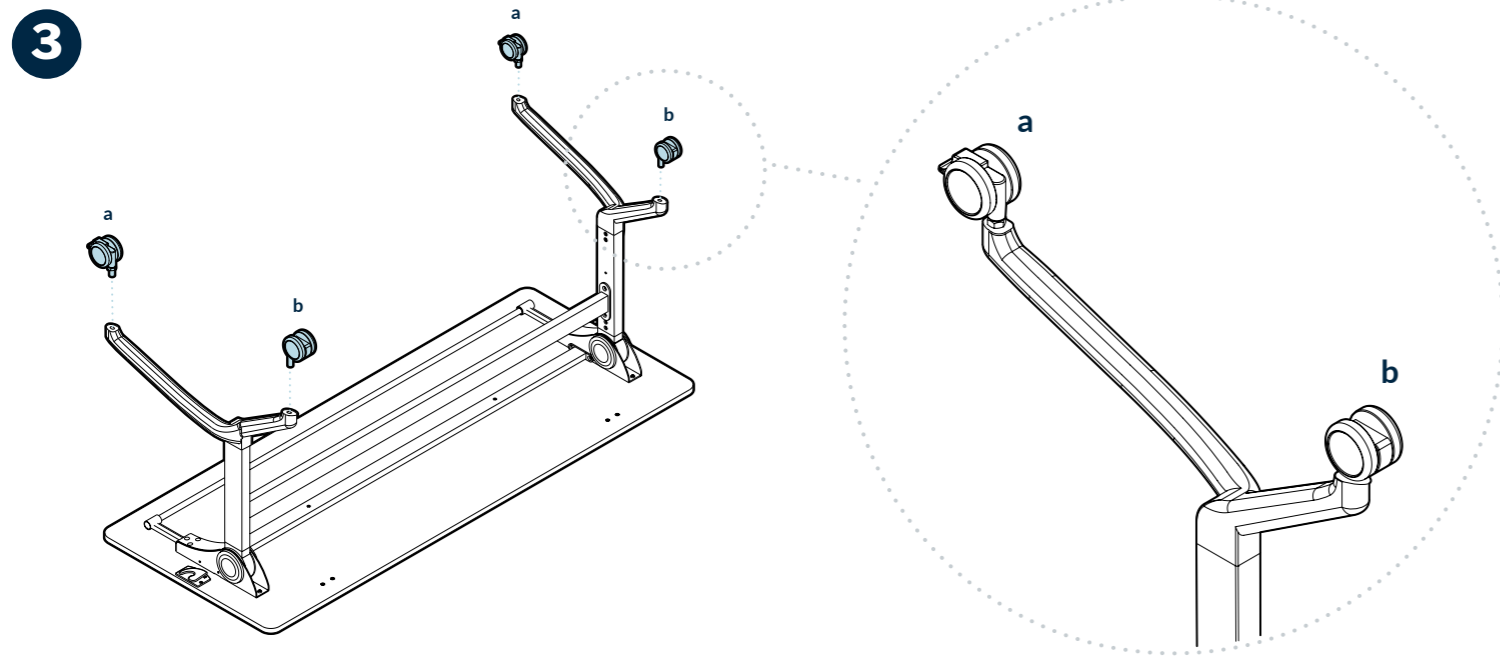

To insert the casters, first line up the casters that have a lock (a) with the longest feet closest to the locking mechanism and press down until the caster is flat against the foot. Then, line up the casters that do not have a lock (b) with the shortest feet and again press down until the caster is flat against the foot.

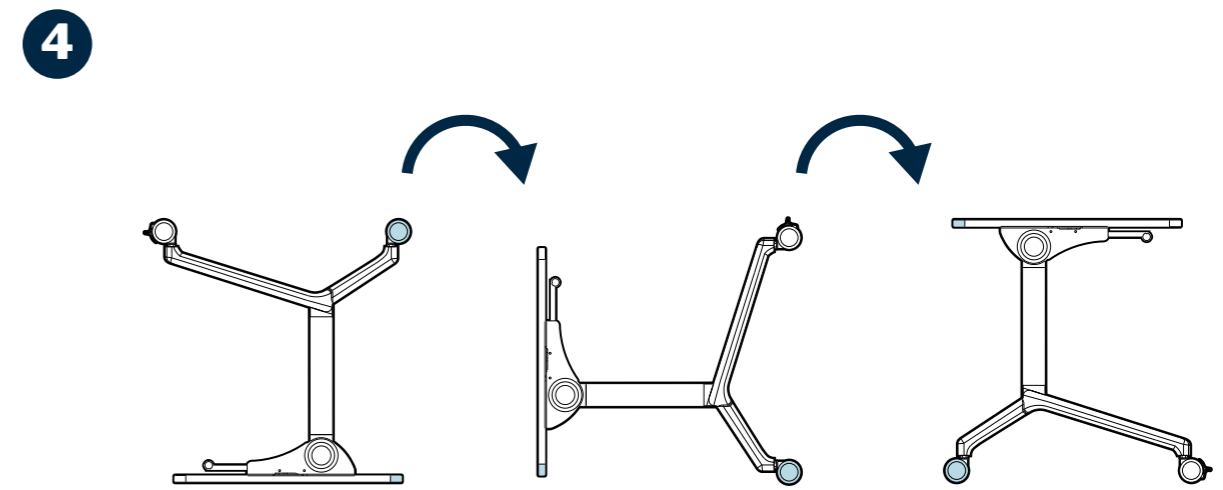

Note: Before flipping the table, lock the two locking casters. With one person on each end of the table, lift and rotate the table so that the front edge and wheels are resting on the ground. Lift and rotate the table again, gently setting all four wheels on the ground.

Linking Multiple Tables Together

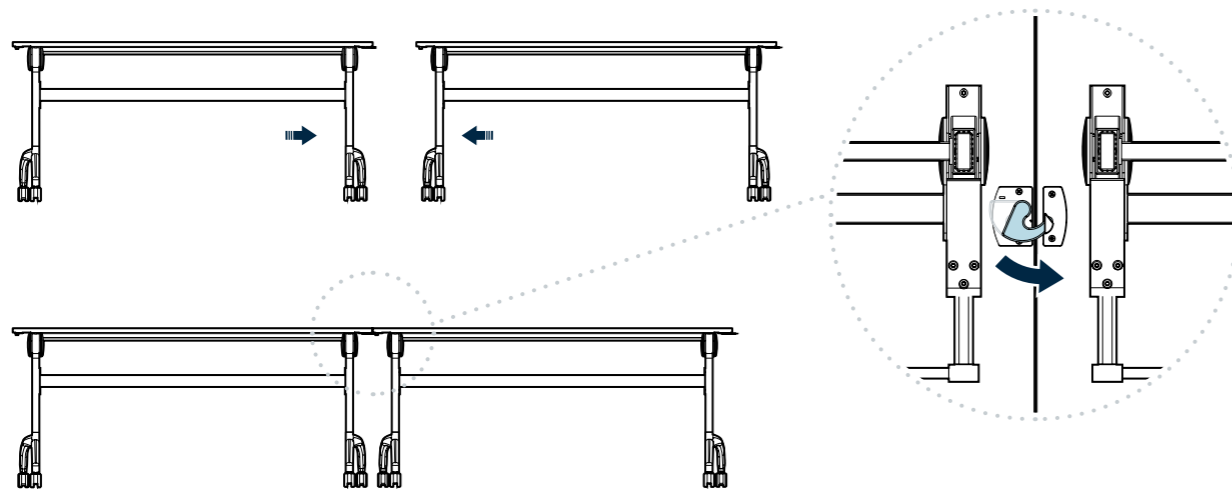

To link multiple tables together, line them up side-by-side facing the same direction. Once in place, rotate the latch hook on the underside of one table through the latch on the underside of the second table.

Storing Tables

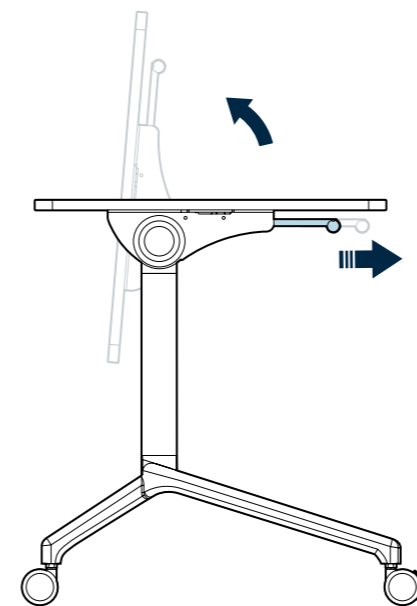

With two hands, pull and hold the locking mechanism out toward the table edge, then tilt the table top into the upright position. Once it is in place, release the locking mechanism.

Nesting Tables

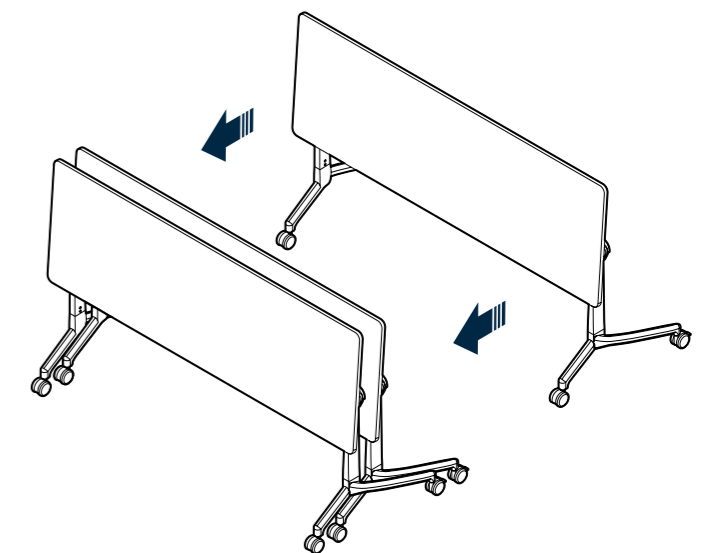

When the Flip Top Training Table is in the upright position, multiple tables can be nested together for storage. Position the tables to face the same direction, align each end, and push them together, carefully guiding the legs of the back table between the legs of the front table.