

Modular Collection

vari.[®]



Make any casual area a multipurpose space with this modular sofa that can be arranged in a variety of ways. This flexible setup gives you the ability to change the configuration anytime you need to without sacrificing comfort. Pictured: Sectional Sofa, Sectional Table, Laptop Side Table.

- Sectional sofa is customizable—pieces sold separately
- Black metal frame on all items
- Commercial-grade durability tested to 100,000 double rubs
- 100% polyester fabric with Grade 4 color-fastness and Class 4 pilling resistance

Fabric Colors



Navy



Deep Gray



Light Gray

SECTIONAL SOFA

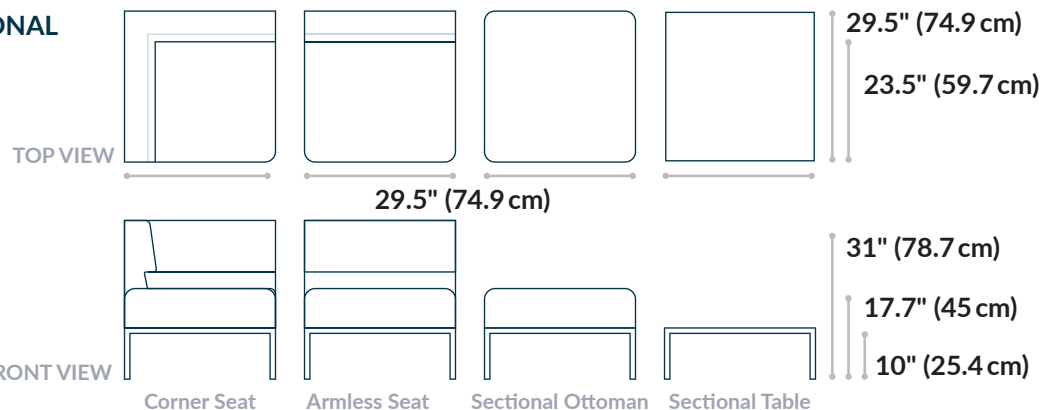

LAPTOP SIDE TABLE

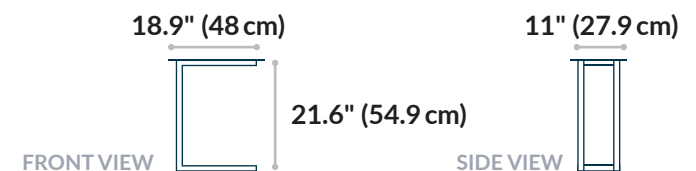

Executive Collection

vari[®]



Deep, nautical tones and warm wood finishes give this collection a polished and professional look that will fit seamlessly into any executive space whether it's for waiting, working, or meeting. Pictured: Three-Seat Sofa, Lounge Chair, and Coffee Table.

- Table finish is walnut laminate
- Chair has 3" height range
- Commercial-grade durability tested to 100,000 double rubs
- 100% polyester fabric with Grade 4 color-fastness and Class 4 pilling resistance

Fabric Colors



Navy



Deep Gray

THREE-SEAT SOFA

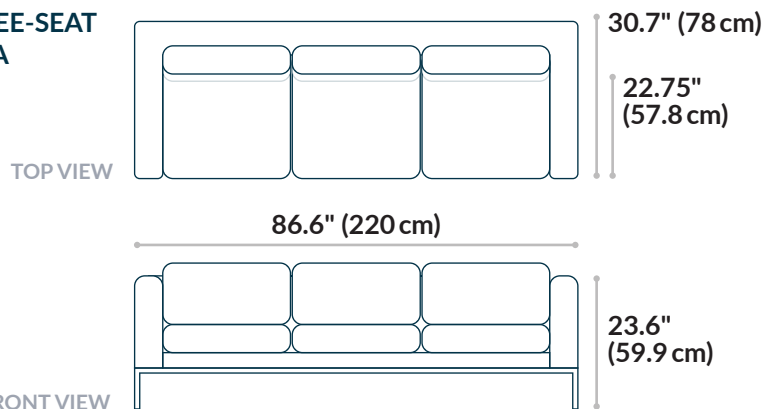

LOUNGE CHAIR

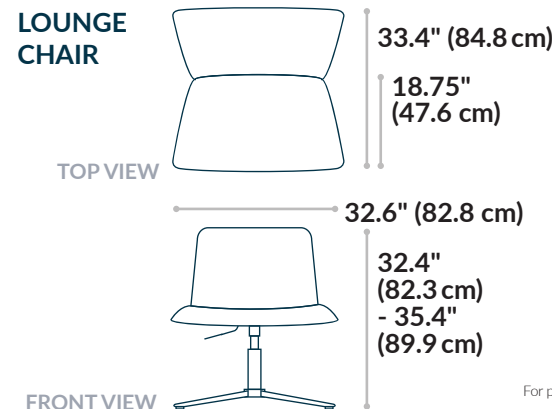

COFFEE TABLE

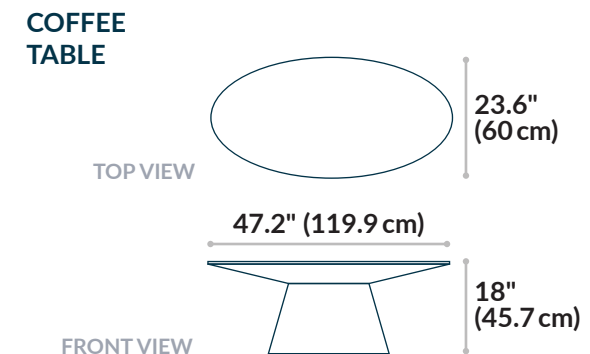

Lounge Collection

vari®



When it's time for a quick check-in or a casual brainstorming session, these ottomans bring laid-back comfort to any lounge area or informal meeting space. They can also serve as a convenient resting place for your laptop. Pictured: Two Large Ottomans and one Small Ottoman.

- Large Ottoman colors: light gray, navy
- Small Ottoman colors: light gray, light blue, green
- Commercial-grade durability tested to 100,000 double rubs
- 100% polyester fabric with Grade 4 colorfastness and Class 4 pilling resistance

Fabric Colors



Navy

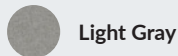

Light Gray



Light Blue

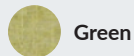

Green

LARGE OTTOMAN

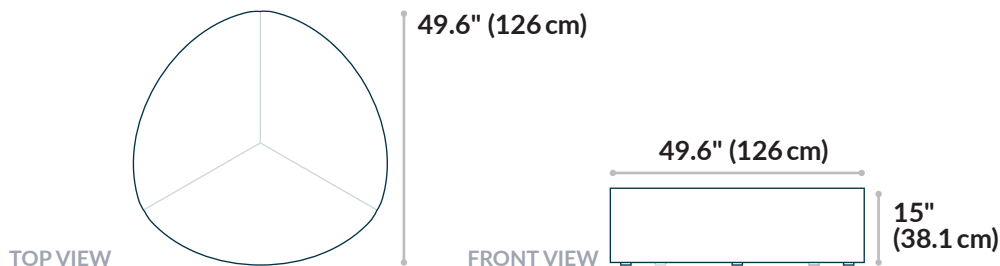

SMALL OTTOMAN

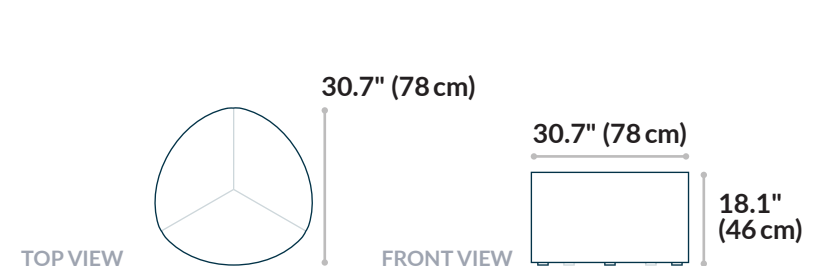

Casual Meeting Collection



This collection makes it easy to put together a simple discussion area for one-on-ones or small group meetings. The chairs are professional yet comfortable and the table is just the right size to give everyone space for their coffee or laptops. Pictured: Four Arm Chairs and Round Coffee Table.

- Chair color options: deep gray, navy
- Both pieces made with black metal frame
- Round Side Table available for smaller, two-chair arrangements
- Commercial-grade durability tested to 100,000 double rubs
- 100% polyester fabric with Grade 4 color-fastness and Class 4 pilling resistance

Fabric Colors



Navy



Deep Gray

ARM CHAIR

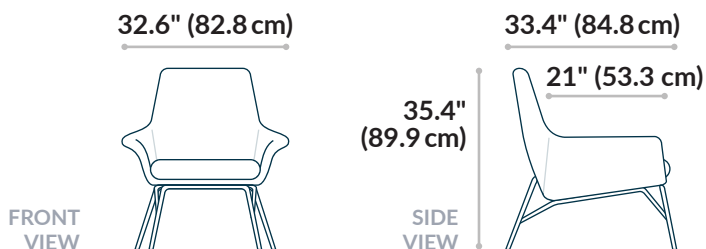

ROUND COFFEE TABLE

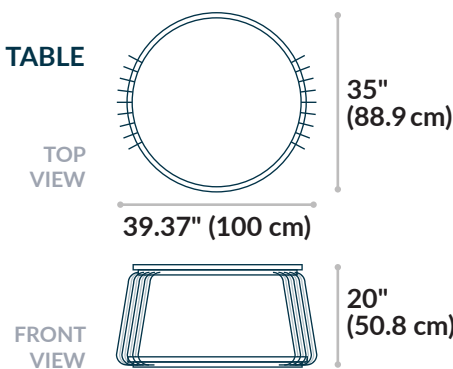

ROUND SIDE TABLE

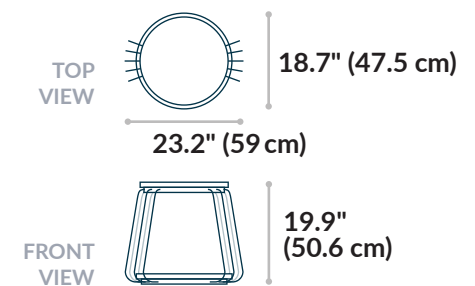

Quiet Seating Collection



The sofa in this collection is designed to provide both comfort and privacy in one eye-catching signature piece. Great for focus work or more sensitive conversations, the High Back Sofa pairs perfectly with our Lounge Table. Pictured: Two High Back Sofas and one Lounge Table.

- Sofa is light gray with a navy accent and black metal legs
- Table has a white top with a black metal frame
- Commercial-grade durability tested to 100,000 double rubs
- 100% polyester fabric with Grade 4 color-fastness and Class 4 pilling resistance

Fabric Colors



Light Gray
Navy

HIGH BACK SOFA

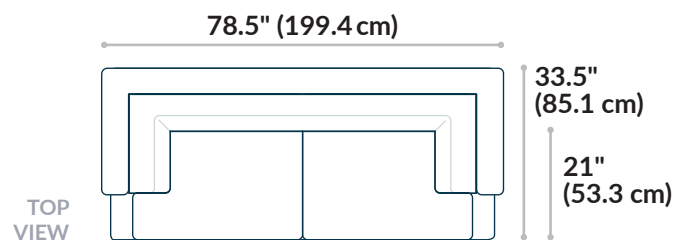
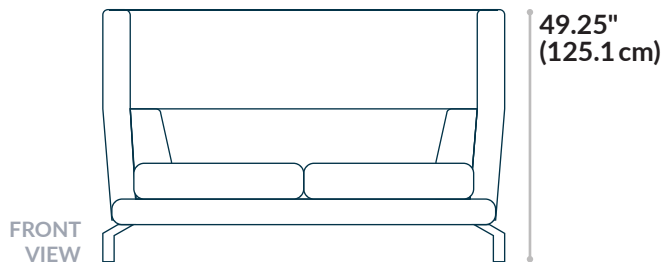

LOUNGE TABLE

